

Schlauchschellen

nach DIN 3017
Hose holder according to DIN 3017

mit Schneckengewinde

Materialien:
Oberfläche:
Bandabmessung: 12mm Breite
Bandabmessung: 8mm Breite
Schnecke:

Stahl
glanz verzinkt
S=0,8mm
S=0,65mm
SW7 / SW8
einsatzgehärtet

with screw flight

Materials:
Surface:
Belt: 12mm wide
Belt: 8mm wide
Screw:
steel
glossy zinc-coated
S=0,8mm
S=0,65mm
CH7 / CH8
case hardened

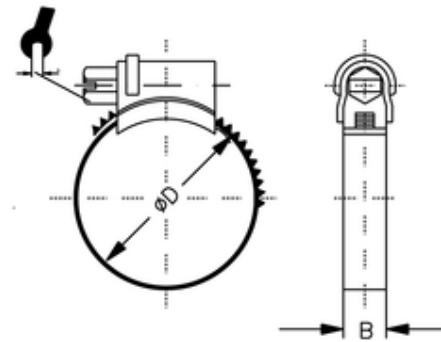

ITV

657470

B

12

ØD

150-170