

Schlauchschellen

nach DIN 3017

Hose holder according to DIN 3017

Fascetta Fermatubo DIN 3017

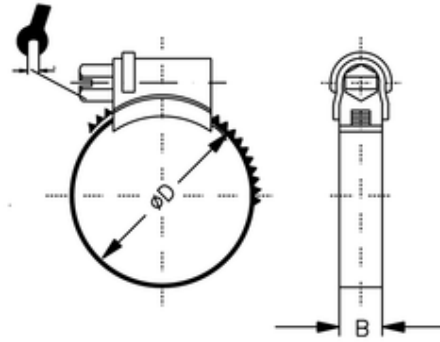

| ITV | B | ØD |
|--------|----|---------|
| 657480 | 12 | 160-180 |

mit Schneckengewinde

With screw flight

vite senza fine

| | |
|------------|----------------------------|
| Material: | Stahl, glanz verzinkt. |
| Material: | steel, glossy zinc-coated. |
| Materiale: | acciaio, zincato lucido. |
| Schraube: | SW7/ SW8 |
| Screw: | AF7 / AF8 |
| Vite: | CH7 / CH8 |