

Doppelnippel konisch

Double nipple, con.

Betriebstemperatur: max. +200°C
Betriebsdruck: bis 16bar
Werkstoff: Edelstahl AISI 316
Gewinde: zyl. Gewinde DIN 3852
 kon. Gewinde DIN 3858

Operating temperature: max. +200°C
Operating pressure: up to 16bar
Material: Stainless steel AISI 316
Thread: cyl. thread DIN 3852
 con. thread DIN 3858

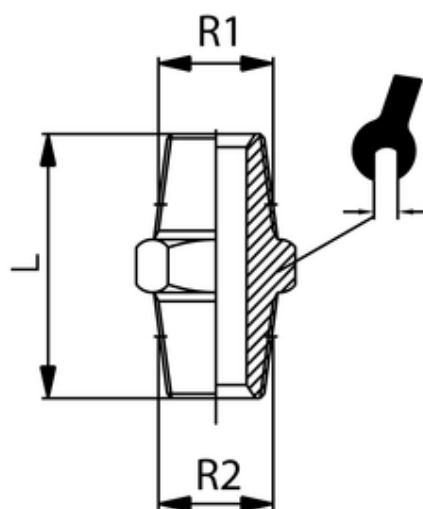

ITV	R1	R2	L	SW
82208	R3/4	R1/2	41	28