

Doppelnippel konisch

Double nipple, con.
Niplo conico, M.M.

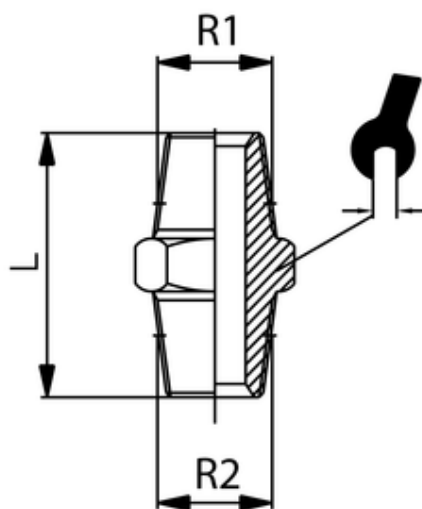

ITV	R1	R2	L	sw
82221	R1 1/2	R1 1/4	53	51

Betriebstemperatur: max. +200°C
Betriebsdruck: bis 16bar
Werkstoff: Edelstahl AISI 316
Gewinde: zyl. Gewinde DIN 3852
kon. Gewinde DIN 3858

Operating temperature: max. +200°C
Operating pressure: up to 16bar
Material: Stainless steel AISI 316
Thread: cyl. thread DIN 3852
con. thread DIN 3858