

# Doppelnippel konisch

Double nipple, con.

**Betriebstemperatur:** max. +200°C  
**Betriebsdruck:** bis 16bar  
**Werkstoff:** Edelstahl AISI 316  
**Gewinde:** zyl. Gewinde DIN 3852  
 kon. Gewinde DIN 3858

**Operating temperature:** max. +200°C  
**Operating pressure:** up to 16bar  
**Material:** Stainless steel AISI 316  
**Thread:** cyl. thread DIN 3852  
 con. thread DIN 3858

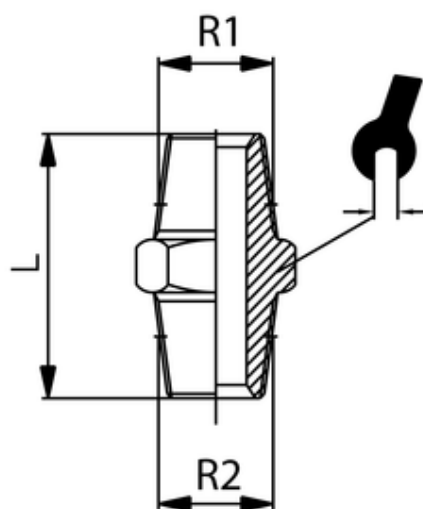

ITV	R1	R2	L	SW
82223	R2	R3/4	64	53