

Reduzierung

Reducer
Riduzione M.F. conica

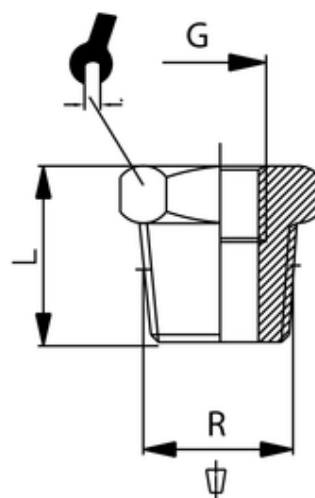

ITV	R	G	L	sw
82811	R1	G3/4	27,5	38

Betriebstemperatur: max. +200°C
Betriebsdruck: bis 16bar
Werkstoff: Edelstahl AISI 316
Gewinde: zyl. Gewinde DIN 3852
kon. Gewinde DIN 3858

Operating temperature: max. +200°C
Operating pressure: up to 16bar
Material: Stainless steel AISI 316
Thread: cyl. thread DIN 3852
con. thread DIN 3858