

T-Stück IG

Female T
T - F.F.F.

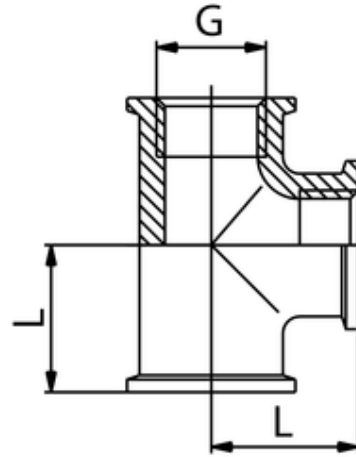

ITV	G	L
84010	G2	58

Betriebstemperatur:	max. +200°C
Betriebsdruck:	bis 16bar
Werkstoff:	Edelstahl AISI 316
Gewinde:	zyl. Gewinde DIN 3852 kon. Gewinde DIN 3858

Operating temperature:	max. +200°C
Operating pressure:	up to 16bar
Material:	Stainless steel AISI 316
Thread:	cyl. thread DIN 3852 con. thread DIN 3858