

# Winkel 90° I-I

Elbow 90° F-F  
Gomito F.F.

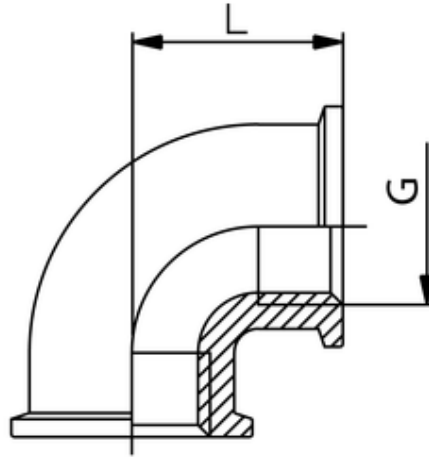

ITV	G	L
85106	G3/4	33

<b>Betriebstemperatur:</b>	max. +200°C
<b>Betriebsdruck:</b>	bis 16bar
<b>Werkstoff:</b>	Edelstahl <span style="float: right;">AISI 316</span>
<b>Gewinde:</b>	zyl. Gewinde DIN 3852 kon. Gewinde DIN 3858

<b>Operating temperature:</b>	max. +200°C
<b>Operating pressure:</b>	up to 16bar
<b>Material:</b>	Stainless steel <span style="float: right;">AISI 316</span>
<b>Thread:</b>	cyl. thread DIN 3852 con. thread DIN 3858