

# HDS 01

Gerade Einschraubverschraubung zyl.  
Straight male adaptor cyl.  
Diritto maschio cilindrico con O-Ring

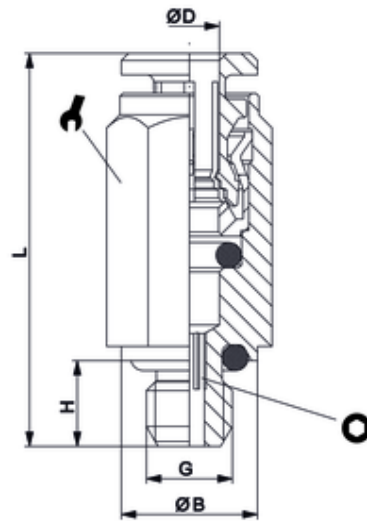

ITV	ØD	G	ØB	H	L	isw	sw
H200122	4	M6x1	9,5	6	27,5	2	10