

HDS 022

Winkeleinschraubverschraubung drehbar zyl.
Rotary elbow male adaptor cyl.
Gomito maschio girevole cil. con O-Ring

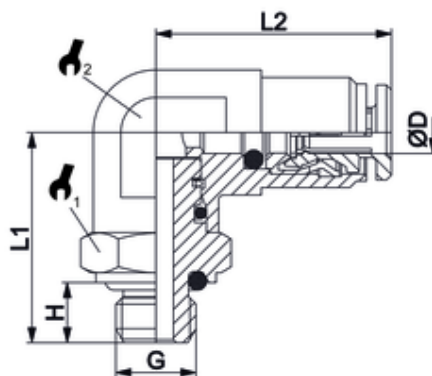

ITV	ØD	G	H	L1	L2	sw1	sw2
H202225	6	M6x1	6	21	25,5	13	13