

# HDS 022

Winkeleinschraubverschraubung drehbar zyl.  
Rotary elbow male adaptor cyl.  
Gomito maschio girevole cil. con O-Ring

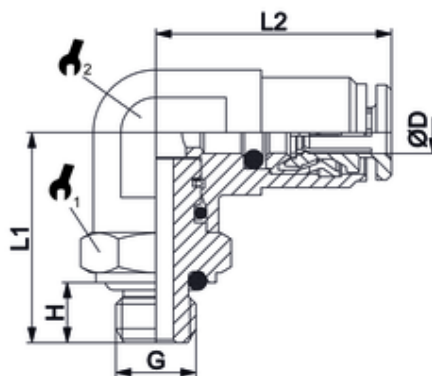

ITV	ØD	G	H	L1	L2	sw1	sw2
H202247	6	M8x1	6	21	25,5	13	13